

GEM: Green ELECTRIC Module

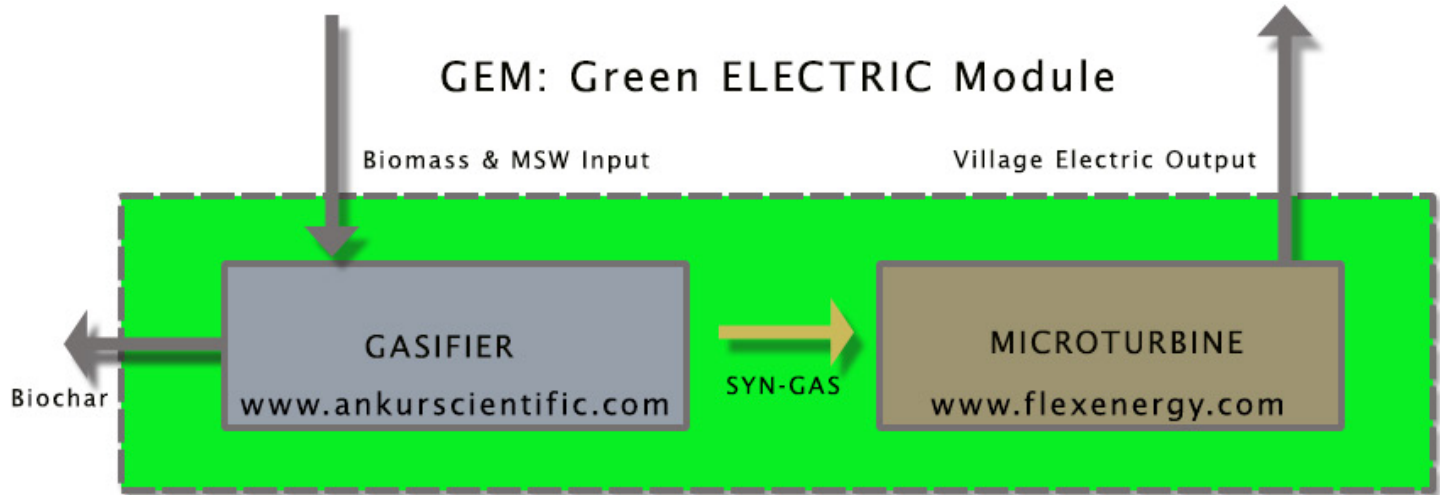

Input = Ankur

Output = Flex Energy & Siemens

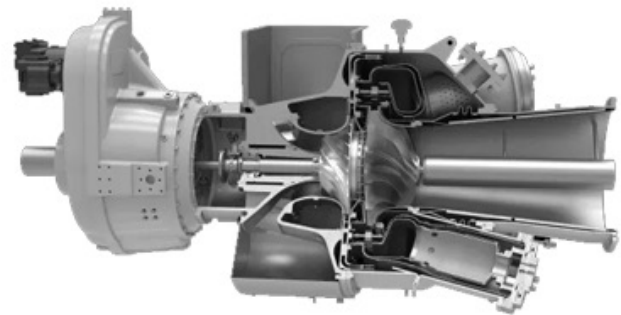
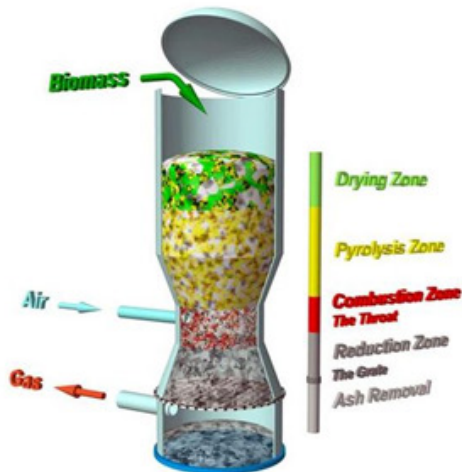

SGT-50 POWERED by SIEMENS

GFM: Green FUEL Module

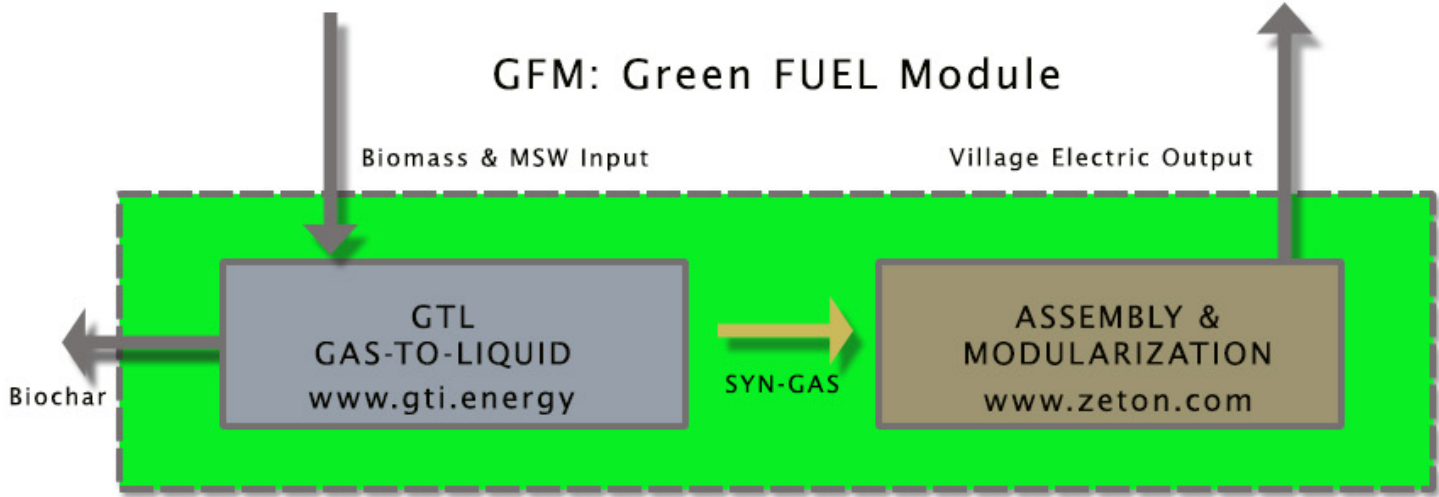

Input = GTI Energy

Assembly & Modules = Zeton

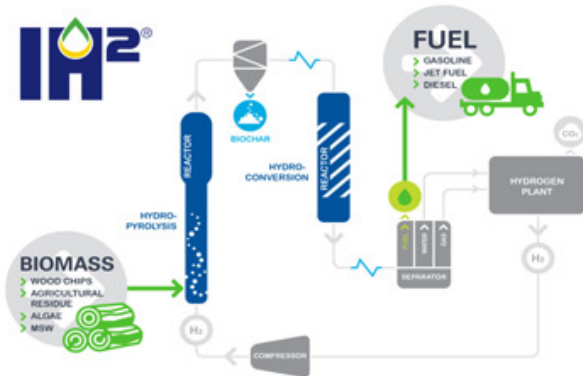

GSM: Green SLUDGE Module

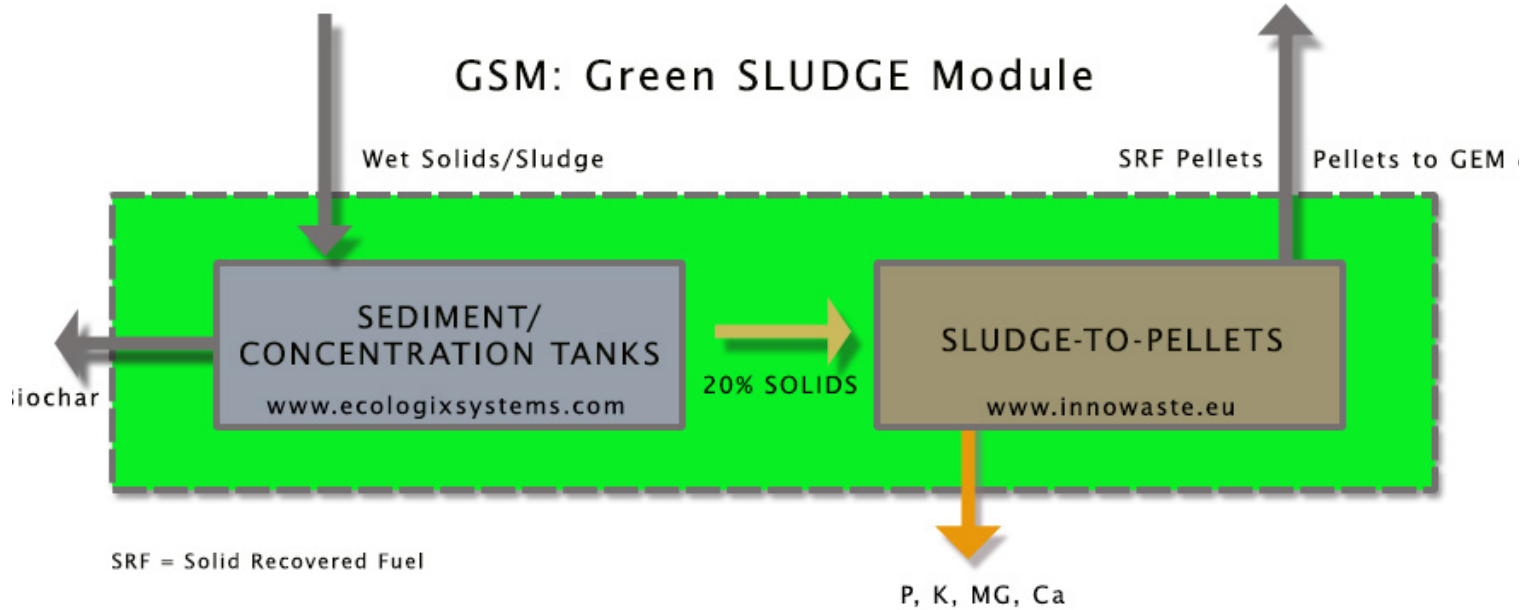

Input = Ecologix

Output = Innowaste

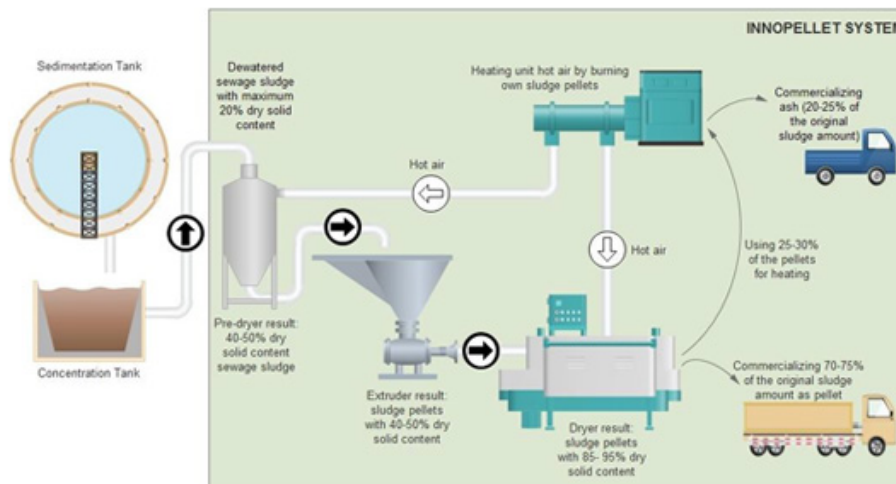

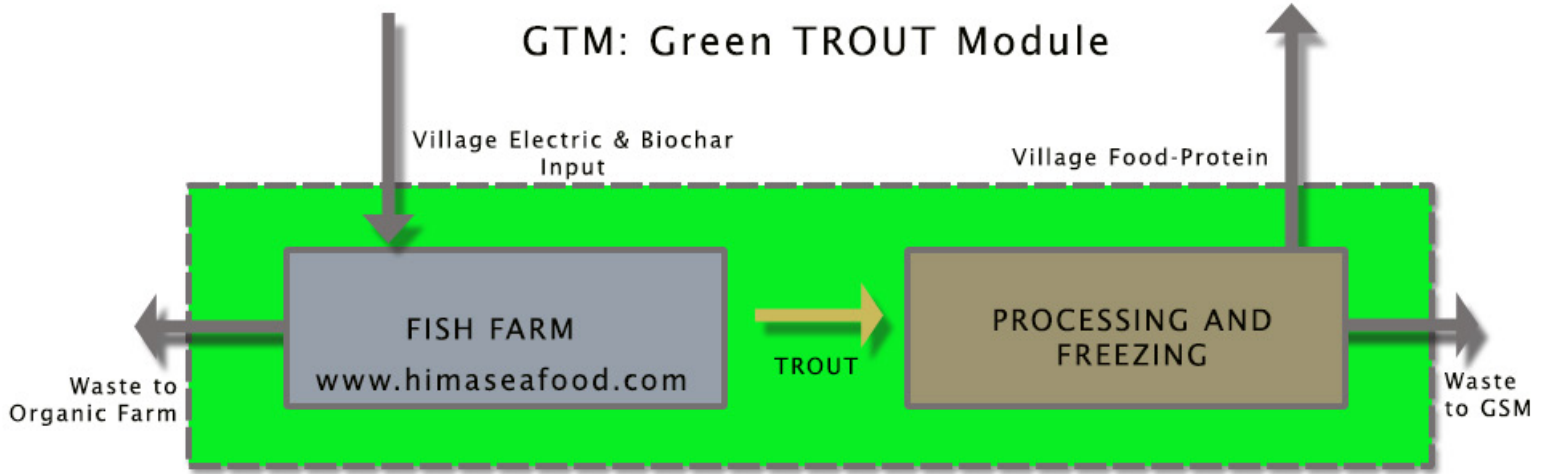

Input = HIMA

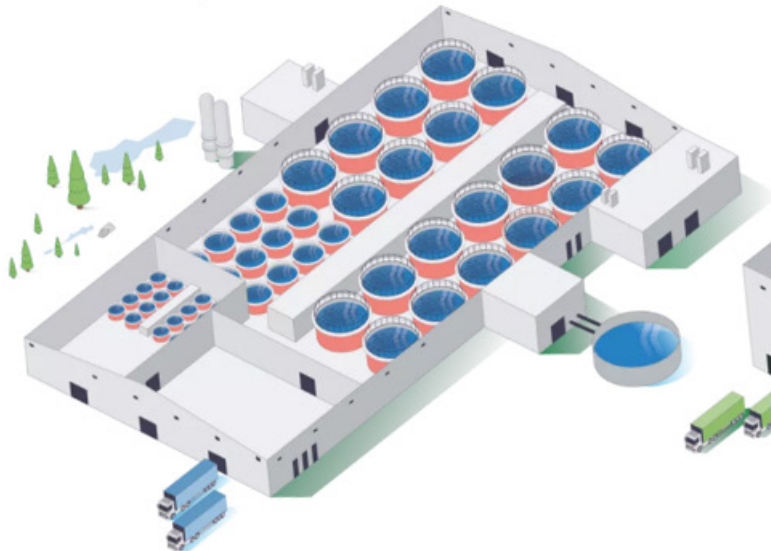

Output = HIMA

